



ergoárea mobiário de escritório



Ref.º C01



Ref.º C02



Ref.º C03



Ref.º C04



Ref.º C05

Costa: Média, alta, com encosto de cabeça. Regulável em altura.
Assento: Espuma flexível.
Base: Poliamida.
Mecanismo: Contacto permanente. Up&Down ou synchrón.
Braços: Fixos ou reguláveis.
Versão de Visitante: Disponível em estrutura trenó sem braços, trenó com braços ou 4 pés com braços.

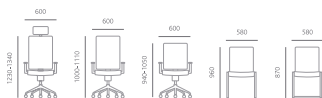

Ref.º C06



Ref.º C07

Costa: Alta ou média. Espuma flexível. Regulável em altura.
Assento: Espuma flexível.
Base: Poliamida.
Mecanismo: Contacto permanente ou synchrón.
Braços: Fixos fechados, fixos em T ou reguláveis em altura.

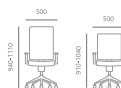

Ref.º C12

Costa: Média ou alta. Regulável em altura.
Assento: Espuma flexível.
Base: Poliamida.
Mecanismo: Fixo ou contacto permanente.
Braços: Fixos. Polipropileno ou poliamida.
Outras versões: Versão trenó ou 4 pés em estrutura tubo de aço. Versão de estrador também disponível.



Ref.º C13

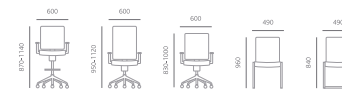

Ref.º C14



Ref.º C15



Ref.º C08



Ref.º C09



Ref.º C10



Ref.º C11

Costa de configuração rectangular confere distinção e conforto ao utilizador.
Costa: Média ou alta.
Assento: Espuma flexível.
Base: Poliamida ou alumínio.
Mecanismo: Contacto permanente ou synchrón.
Braços: Reguláveis em altura.
Versão de Visitante: Estrutura em tubo de aço cromado, versão trenó com braços.

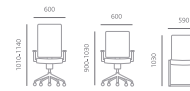

Ref.º C16

Costa: Baixa, média ou alta. Regulável em altura.
Assento: Espuma flexível.
Base: Poliamida.
Mecanismo: Contacto permanente.
Braços: Fixos. Em poliamida.
Outras versões: Versão trenó ou 4 pés em estrutura tubo de aço. Versão de estrador também disponível.



Ref.º C17

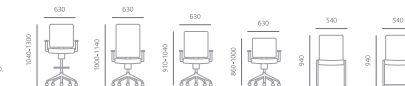

Ref.º C18



Ref.º C19



Ref.º C20



Ref.º C21



Ref.º C22

Costa: Baixa, média e alta. Regulável em altura.
Assento: Espuma flexível.
Base: Poliamida.
Mecanismo: Fixo ou contacto permanente.
Braços: Fixos. Polipropileno ou poliamida.
Outras versões: Versão trenó ou 4 pés em estrutura tubo de aço. Versão de estrador também disponível.

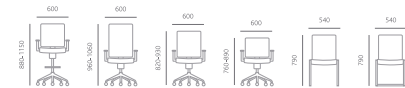



ergoárea

mobiliário de escritório



Ref.º C24



Ref.º C25



Ref.º C26



Ref.º C27



Ref.º C28



Ref.º C29



Ref.º C30



Ref.º C31



Ref.º C32



Ref.º C33



Ref.º C34



Ref.º C35



Ref.º C36



Ref.º C37



Ref.º C38



Ref.º C39



Ref.º C40



Ref.º C41



Ref.º C42



Ref.º C43



Ref.º C44

Ref.º C45

Cadeira direccional de design simples e clássico.

Costa: Média ou alta.
Assento: Espuma flexível.
Base: Poliamida.
Mecanismo: Oscilante sincronizado.
Braços: Fixos. Revestimento no topo opcional.
Versão de Visitante: Estrutura em tubo de aço, versão trend.

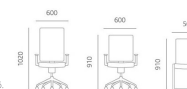

Ref.º C46



Ref.º C47



Ref.º C48



Ref.º C49



Ref.º C50



Ref.º C51

Costa: Alta ou média. Espuma flexível.
Assento: Espuma flexível.
Base: Poliamida ou alumínio polido.
Mecanismo: Oscilante.
Braços: Fixos fechados em polipropileno.

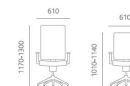

Costa: Alta. Em rede. Suporte lombar regulável em altura.
Assento: Espuma moldada.
Base: Poliamida ou alumínio.
Mecanismo: Sincron.
Braços: Fixos em T ou reguláveis.
Versão de Visitante: Estrutura em tubo de aço cromado. Versões trend ou 4 pés com braços.

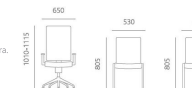

ergoárea

mobiliário de escritório



Ref.ª C52



Ref.ª C53



Ref.ª C54

Costa: Revestida (alta ou média) ou em polipropileno preto ou branco (apenas média) ou em rede.
Assento: Revestido com estofo em espuma flexível ou em polipropileno (preto ou branco).
Estrutura: Tubular em aço. Pintada ou com acabamento cromado.
Braços: Integrados na estrutura com apoio.
Outras versões: Versão giratória com elevação a gás e mecanismo oscilante.



Ref.ª C64



Ref.ª C65



Ref.ª C66



Ref.ª C67



Ref.ª C68



Ref.ª C69



Soluções variadas de bancos de trabalho.



Ref.ª C55



Ref.ª C56



Ref.ª C57



Ref.ª C58



Ref.ª C59



Ref.ª C60



Ref.ª C70



Ref.ª C71

Costa: Polipropileno, falia, rede ou revestida, espuma flexível (4000) ou espuma moldada (400).
Assento: Polipropileno, falia ou revestida, espuma flexível (4000) ou espuma moldada (400).
Braços: Fixos (opcionais) em polipropileno ou poliuretano. Palmatória.
Versão de Visitante: 4 pés e viga até 5 lugares.



Costa: Polipropileno.
Assento: Polipropileno.
Braços: Fixos (opcionais).
Versão de Visitante: 4 pés.
Estrutura: Pintada a preto ou alumínio ou cromada.



Ref.ª C61



Ref.ª C62



Ref.ª C63

Costa: Revestimento frontal.
Assento: Revestido. Espuma flexível.
Braços: Fixos (opcionais).
Versão de Visitante: 4 pés.
Estrutura: Pintada a preto ou cinza ou cromada.



Costa: Polipropileno ou revestimento frontal.
Assento: Polipropileno ou revestido. Espuma flexível.
Braços: Fixos (opcionais).
Versão de Visitante: 4 pés.
Estrutura: Pintada a preto ou cinza ou cromada.



Ref.ª C72



Ref.ª C73



Ref.ª C74



Ref.ª C75

Costa e Assento: Monocasco em polipropileno.
Estrutura: 4 pés em tubo de aço cromado, trêns em varão de aço cromado ou 4 pés em tubo quadrado cromado.
Braços: Integrados na estrutura (apenas na versão tubo quadrado).

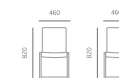



ergoárea

mobiliário de escritório



Ref.º C76



Ref.º C77



Ref.º C78



Ref.º C91



Ref.º C92



Ref.º C93



Ref.º C94



Ref.º C79



Ref.º C80



Ref.º C81



Ref.º C82



Ref.º C95



Ref.º C96



Ref.º C97



Ref.º C98



Ref.º C83



Ref.º C84



Ref.º C85



Ref.º C86



Ref.º C99



Ref.º C100



Ref.º C101



Ref.º C102



Ref.º C87



Ref.º C88



Ref.º C89



Ref.º C90



Ref.º C103



Ref.º C104



Ref.º C105



Ref.º C106



Ref.º C107



ergoárea

mobiliário de escritório



Ref.º C108



Ref.º C109



Ref.º C110



Ref.º C111



Ref.º C120



Ref.º C121



Ref.º C122



Ref.º C123



Ref.º C112



Ref.º C113



Ref.º C114



Ref.º C115



Ref.º C124



Ref.º C125



Ref.º C126



Ref.º C116



Ref.º C117



Ref.º C118



Ref.º C119



Ref.º C127



Ref.º C128



Ref.º C129



Ref.º C130



ergoárea
mobiliário de escritório

Cadeiras



Ref.º C131



Ref.º C132



Ref.º C133



Ref.º C135



Ref.º C134



Ref.º C136



Ref.º C137



Ref.º C138



Ref.º C139



Ref.º C140



Ref.º C141

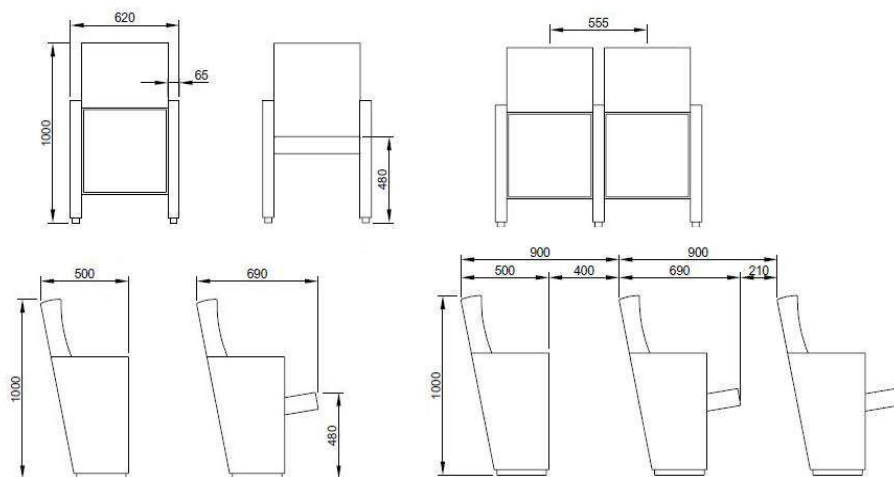

Ref.º C142

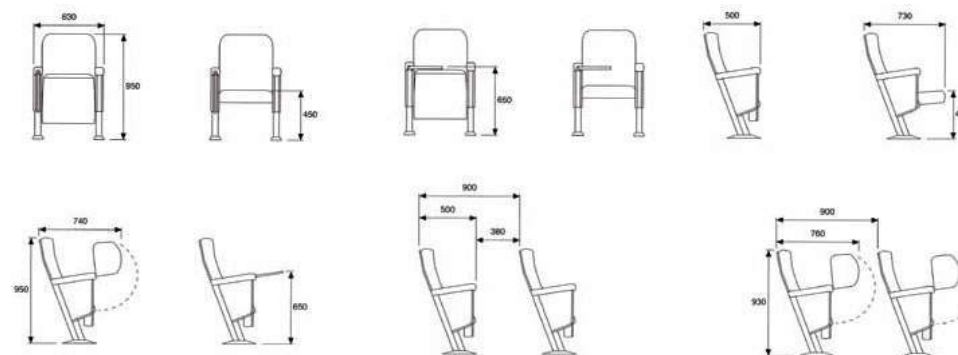



Ref.º C143

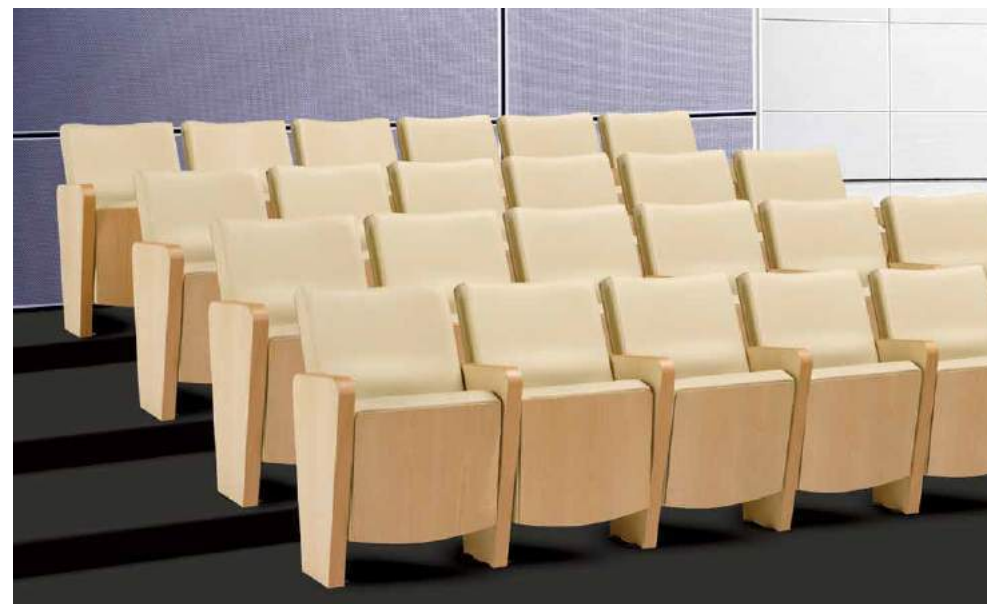
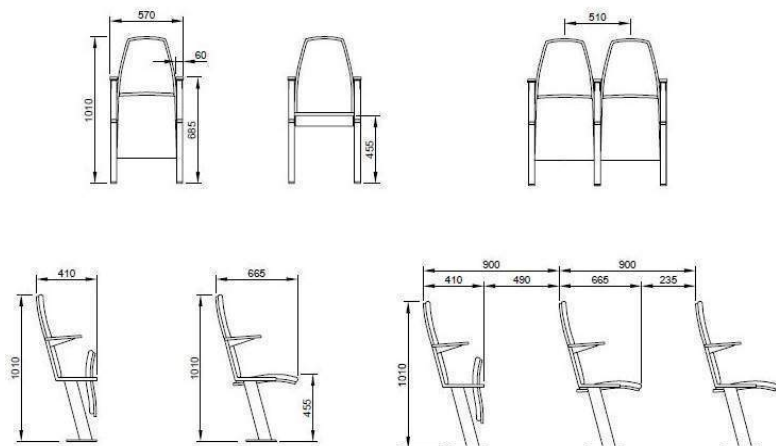

Ref.º C144

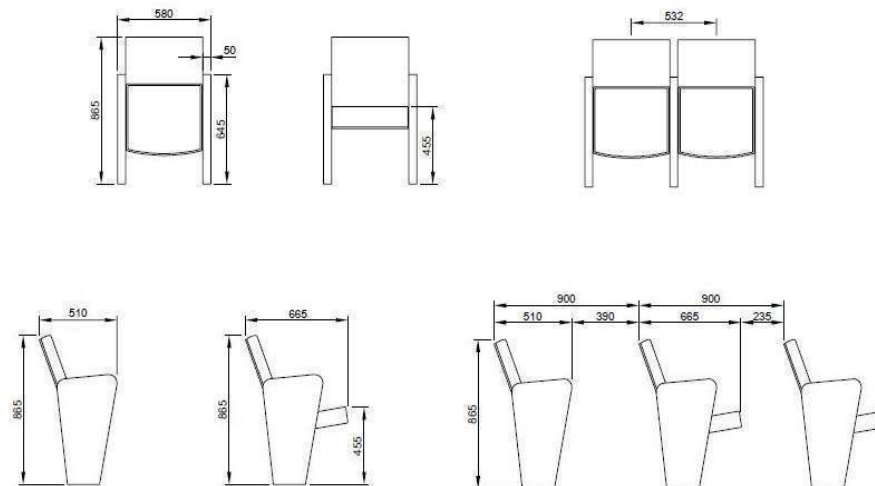



Ref.º C145

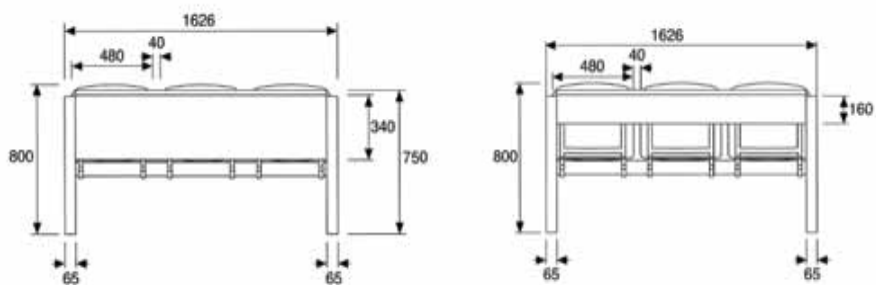

Ref.º C146

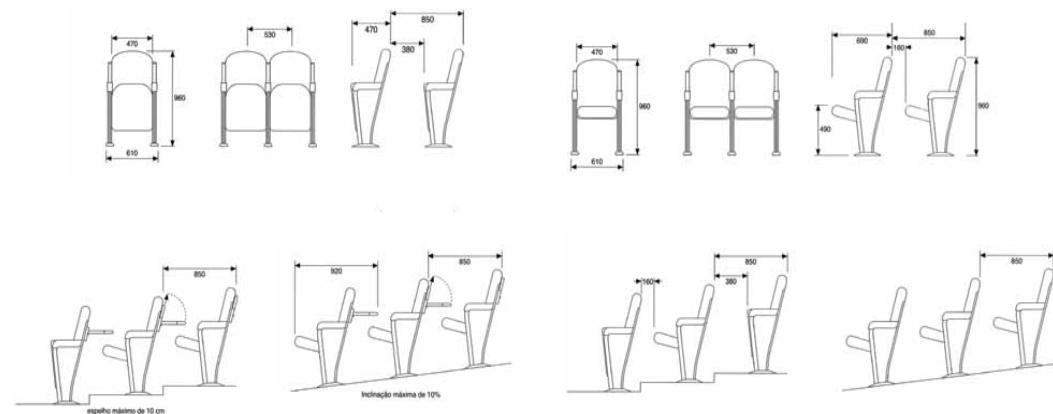



Ref.º C147

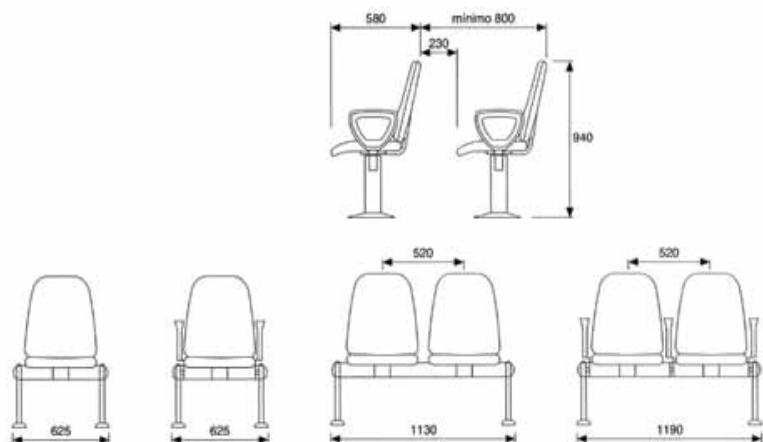

Ref.º C148

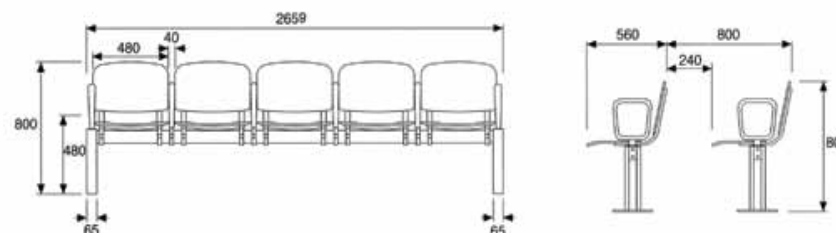



ergoárea
mobiliário de escritório



Ref.º C149



Ref.º C150



Ref.º C151



Ref.º C152



Ref.º C153



Ref.º C154



Ref.º C155



Ref.º C156



ergoárea
mobiliário de escritório



Ref.º C157



Ref.º C158



Ref.º C159



Ref.º C160

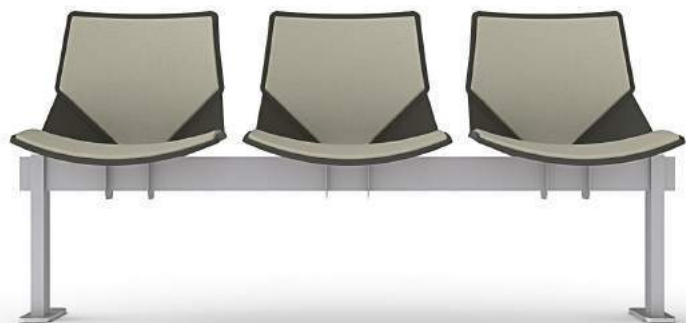

Ref.º C162



Ref.º C163



Ref.º C161



Ref.º C164



Ref.º C166



Ref.º C167



Ref.º C165



Ref.º C168

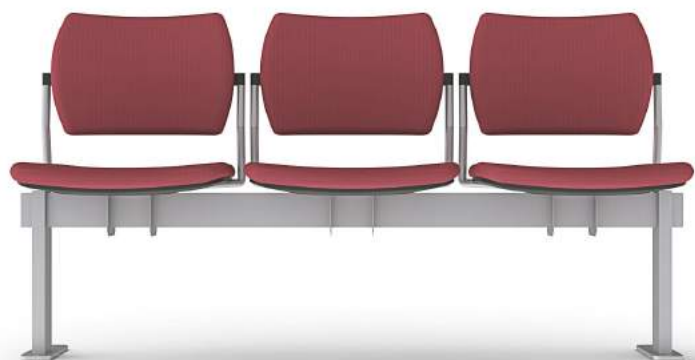

Ref.º C169

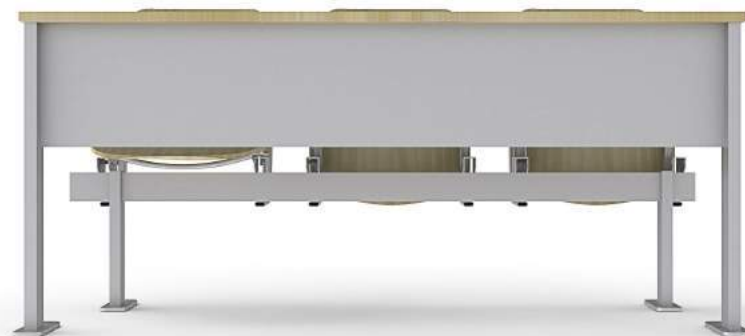

Ref.º C171



Ref.º C170



Ref.º C172

